

CODE: **AWO250 v1.9/III**
 NAME: **17/TRZ50/DSPR**

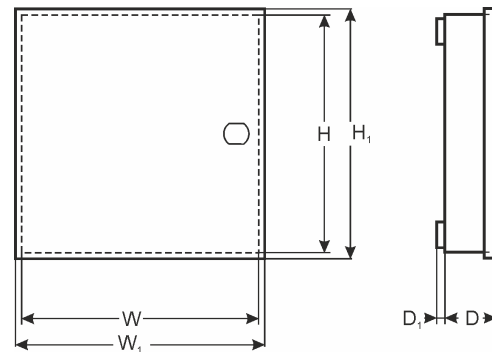

DESTINATION

DSC: PC1616, 1832, 1864, 4020 + 7x 5108 (4108, 5208, 5100, 4116)

PC1616, 1832, 1864, 4020 + 2x (5204, 5400, 5200, 5580, 5008, 4216) + 5x (4108, 5108, 5208, 5100, 4116)

MODULES: 3x (PC5204, 5400, 5200, 5580, 5008, 4216) + 5x (5108, 4108, 5100, 4116, 5208)

4204 + 7x (4108, 5108, 5100, 4116, 5208)

PARADOX: E55, E65, 728ULT, EVO48, EVO192, SP4000, SP5500, SP6000, SP7000) + 4x ZX8 (APR3-ADM2, APR3- HUB2, PGM4)

RISCO: PRO24, 116, 128, 140+ RPO296EPS (RP128 3APS) + 3x EZ16 (E04, EZ8)

SATEL: CA4VI, CA5, CA6

VERSA 5, 10 15, CA10 + 4 x CA10E (CA64E, SM, MST1)

INTEGRA 24, 32 + 4x CA64E (SM)

INTEGRA 64, 128 + 3x CA64E (SM)

MODULES: CA64 (PP, EPS, ADR, O-R, O-ROC, O-OC, OPS-OC, OPS-R, OPS-ROC, VGM- 16, SR, PT SA)+ 4x CA64E (SM)

PYRONIX: MATRIX 424, 816, 832, 832+

TEXECOM: PREMIER 412, 816, 832, 48, 88, 168, 640 + COM30 (ISDN)

TELMOR: TCA- 824+ 2x (TEX800) + TMT1

ROGER: PR402, CPR 32- SE

2x blacha KD (AWO432)

EBS: PX 202A

PULSAR: MS1012, MSR1012, MSR1012

MS2012, MSR2012, MSR2012

MSRK3012

TECHNICAL DATA

External dimensions of the enclosure:	W=320, H=400, D+D1=120+8 [±2 mm]
External dimensions of the front panel:	W1=325, H1=405 [±2 mm]
Weight net/gross:	4,30kg / 4,50kg [±0,1kg]
Battery space:	17Ah/12V Sealed Lead Acid (SLA)
Transformer:	TRZ 50VA/16V/18V/20 in the case of PC/ABS in class UL94-V0, IP43
Power supply	230V/AC (-15%/+10%), 50Hz, 250mA (max.)
Power supply output:	U1=16V/AC or U2=18V/AC or U3=20V/AC(-5%, +15%), I1=3,0A or I2=2,8A or I3=2,5A(max.)
Operating environment:	class II, -10°C+ 40°C
Material description:	sheet steel DC01, thickness: 0,7mm, protection anticorrosion, color: RAL 9003
Destination:	indoor
Tamper protection:	1 x microswitch: opening, 0,5A@50V/DC max. NC
Closing:	screwed x 4
Notes:	optional: lockable, distance from wall (mounting surface) - 8mm, easy door removal
Declaration, warranty:	CE, 2 year from the production date